

COMMERCIAL DATA SHEET

Quadra Sparkling Plus 15 XL & Paddle

Billi®

Billi Quadra Sparkling Plus 15 with XL Levered Dispenser & Paddle Mixer

The Quadra Sparkling Plus is the ultimate in modern design and filtered drinking water appliances delivering instant boiling and chilled filtered water, with the added luxury of sparkling water PLUS a separate sink mixer.

Requiring only cold feed mains supply, the Quadra Sparkling Plus mixes it's own hot water without the need for any additional under-bench space requirements or boosters and utilises underbench ice bank technology to enhance capacity and recovery.

All three drinking water options are conveniently delivered by operating the DDA compliant position sensitive levers on the single above bench XL levered dispenser, with hot and cold water for the sink supplied via separate paddle lever mixer tap ensuring safety & convenience.



XL Levered Dispenser

Paddle Lever Mixer

Quadra Sparkling Under-Bench Unit



Features



SAFE TO OPERATE



ENERGY EFFICIENT



ADJUSTABLE CHILLED TEMPERATURE



ADJUSTABLE SPARKLING LEVEL



ICE BANK TECHNOLOGY



ECO-INTELLIGENCE TECHNOLOGY



RANGE OF FINISHES







HACCP CERTIFIED



ITALO-AUSTRALIAN PARTNERSHIP

Australian Made Boiling Unit * Italian Design & Made Sparkling Unit

PRODUCT SPECIFICATIONS

Water type	Product code	Model name	Dispenser	Suggested no. of people	50° hot water capacity litres (initial drawdown)	50° hot water delivery litres per hour	Boiling water delivery (cups per hour)*	Chilled & Sparkling water delivery (cups per hour)	Power supply (amps)
  BOILING CHILLED   SPARKLING PLUS	906105LP	Quadra Sparkling Plus 15	XL Levered	Up to 100	15	85	Up to 220	200	1 x 10 1 x 15

* Based on a set volume of water being drawn every 30 seconds at an inlet temperature of average temperature 21°C. Each cup is equivalent to 170ml. Usage patterns and draw-off methods can impact recovery.

Accessories

992800 - 70mm Riser & Font

992820 - 70mm Riser

992803 - 120mm Riser & Font

992830 - 120mm Riser



990714 - Tubing Extension Kit for Plus unit - 1.8mtrs

990726 - Tubing Extension Kit for Sparkling unit - 2mtrs

Finishes

Standard Finishes

CH - Chrome

BR - Brushed

MB - Matte Black

MW - Matte White

Special Order Finishes

RG - Rose Gold

BRG - Brushed Rose Gold

GM - Gun Metal Grey

PL - Platinum

UB - Urban Brass

Add the Finish code to the Product Code to finalise your specification, eg. 906105LPMB

TECHNICAL DRAWINGS

PRODUCT DIMENSIONS

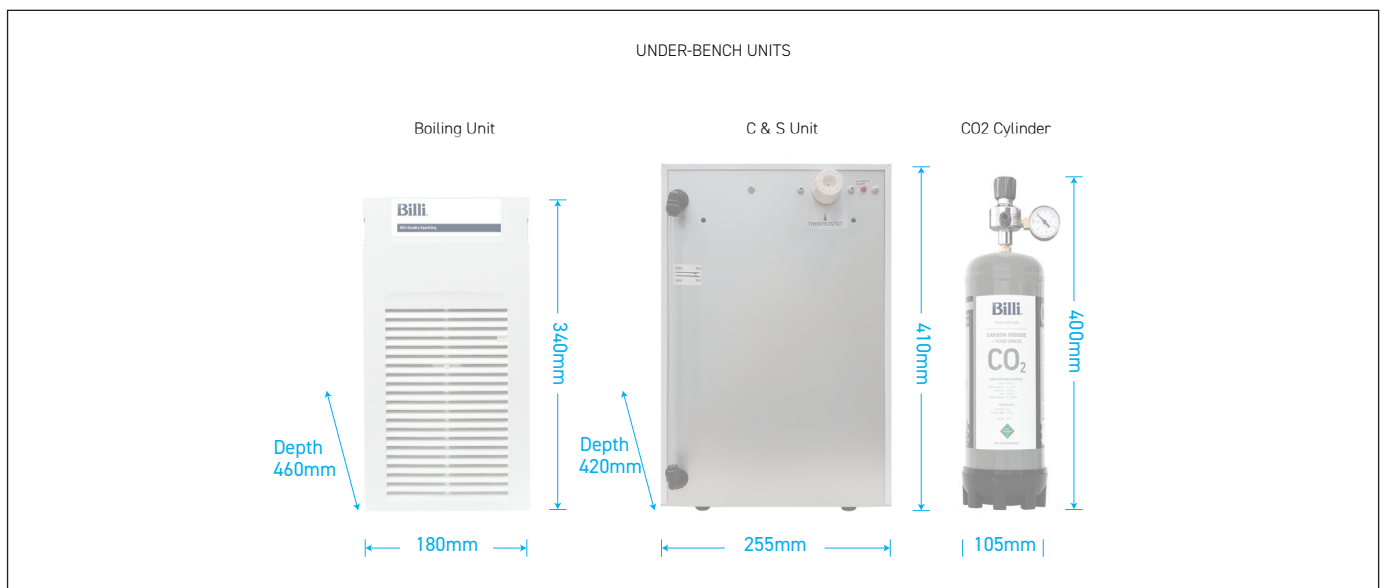
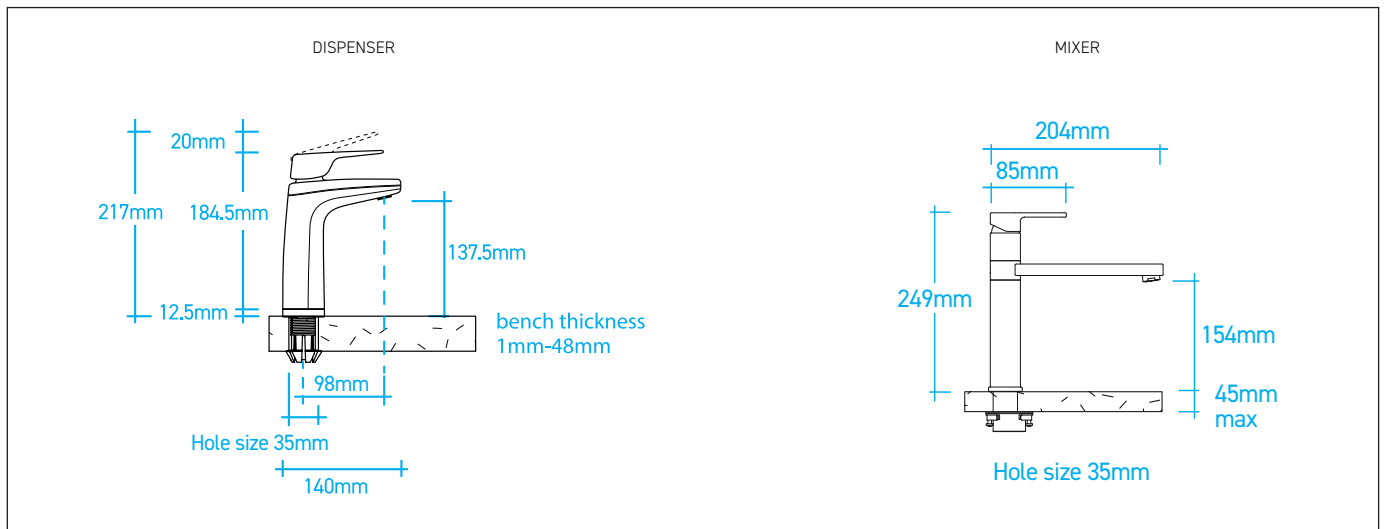

INSTALLATION REQUIREMENTS

PREFERRED INSTALLATION LAYOUT

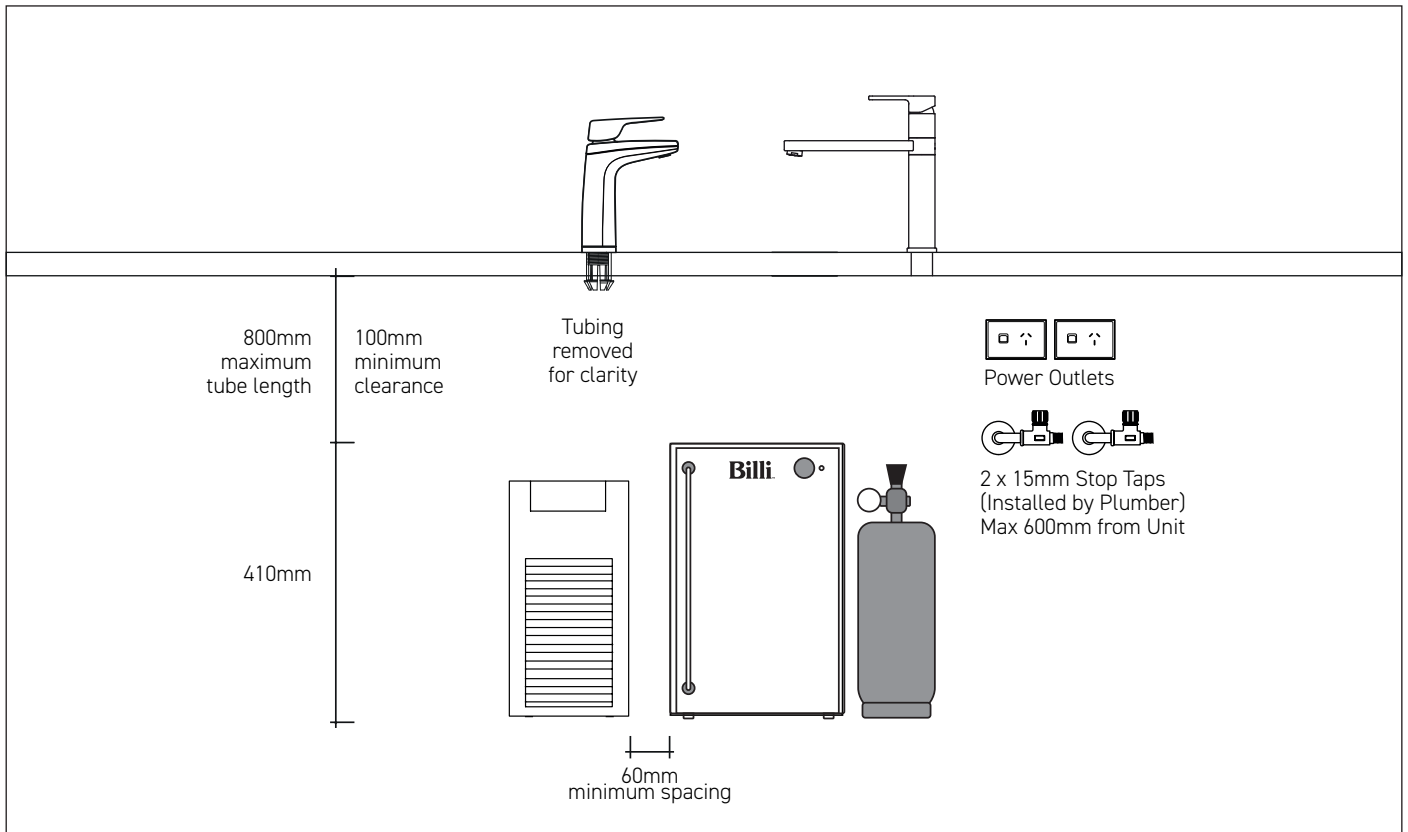

WATER SUPPLY

Two (2) 1/2" BSP (15mm) stop-taps with a male thread should be installed in an easily accessible position. Water supply must be microbiologically safe to drink, with a minimum dynamic water pressure of 250kPa and a maximum of 1000kPa.

POWER SUPPLY

A standard 10 amp power outlet plus an additional standard 15 amp outlet are required. Both outlets located no further than 1000mm from the underbench unit. The system is supplied with a 1 metre flex cord and plug

FILTRATION

Billi's range of premium filters utilise BWT's unique Fibron X technology. Billi's filter range provides superior taste, water quality, consistent filter life and peace of mind when it comes to hygiene.

Filter supplied: 994051 (5 micron). Replacement filters available: 994052 (0.2 micron), 994054 (HSD), 994055 (XPHSD), 994056 (Sediment only) and 994060 (0.2 micron sediment only).

CERTIFICATIONS

Every Billi drinking water appliance is manufactured under a certified quality control system. All Billi commercial range models have been tested and comply with all required standards including: WaterMark: WM-022690; Tested to ATS5200.105 and AS/NZ 4020; ISO 9001:2015, QEC 11627; AS1428; HACCP: PE-872-WAT-1-02; WELL Cornerstone Member; WELS 6 star rating registration T40034.

CO₂ Cylinder

The CO₂ gas cylinder supplied must be secured in a suitable location. Each cylinder contains 1100g of CO₂ and should be installed in a well ventilated area. Each cylinder will provide between 200-350L of sparkling water depending on the unit settings. The MSDS is available on www.billi.com.au for a complete list of specifications and warnings. Replacement gas cylinders are available from Billi. CO₂ Cylinder - single 996911 or double 996912.

WARRANTY

The Billi Quadra Sparkling Plus Range is covered by a comprehensive 2 year warranty on all parts and labour.

Billi®



Billi Australia Pty Ltd

P 1800 812 321
W www.billi.com.au

Billi New Zealand Ltd T/As Merquip

P 0800 636 0 636
W www.merquip.co.nz

visit us at

