

COMMERCIAL DATA SHEET

Sahara Plus 320 XL & Square

Billi®

Billi Sahara Plus 320 with XL Levered Dispenser & Square Mixer

Enjoy all the space saving benefits of Billi's boiling & still Sahara systems PLUS a separate sink mixer to ensure safety and convenience for all users.

Requiring only cold feed mains supply, the Sahara Plus mixes it's own hot water without the need for any additional under-bench space requirements or boosters.

All Sahara Plus boiling & still systems require no joinery ventilation. Supplied standard with a DDA compliant XL levered drinking water dispenser and 6 star rated square gooseneck mixer tap, the solution is both functional and appealing.



BOILING



STILL



PLUS



XL Levered Dispenser

Square Mixer

Sahara Under-Bench Unit



PLUS



Features



SPACE SAVING DESIGN



SAFE TO OPERATE



SPLASHFREE DELIVERY



ENERGY EFFICIENT



NO CUPBOARD VENTILATION REQUIRED



ECO-INTELLIGENCE TECHNOLOGY



AUSTRALIAN DESIGNED & MADE





HACCP CERTIFIED



EASY INSTALLATION

PRODUCT SPECIFICATIONS

Water type	Product code	Model name	Dispenser	Suggested no. of people	50° hot water capacity Ltrs	50° hot water delivery (Ltrs per hour)	Boiling water delivery (cups per hour)*	Still water delivery (cups per hour)	Power supply (amps)
  BOILING STILL	943025LS	Sahara 320 Plus	XL Levered	Up to 25	7	25	120	unlimited	10
 PLUS									

A reserve of boiling water is still available after hot water is fully drawn.

* Based on the initial number of cups of boiling water immediately available, drawn one cup every 10 seconds. For all underbench filtered water systems, consideration may be needed for usage patterns and draw-off methods. 1 cup = 170ml

Accessories

992800 - 70mm Riser & Font



992820 - 70mm Riser



992803 - 120mm Riser & Font



992830 - 120mm Riser



990714 - Tubing Extension Kit for Plus unit - 1.8mtrs

Finishes

Standard Finishes

CH - Chrome

BR - Brushed

MB - Matte Black

MW - Matte White

Special Order Finishes

RG - Rose Gold

BRG - Brushed Rose Gold

PL - Platinum

UB - Urban Brass

GM - Gun Metal Grey

Add the Finish code to the Product Code to finalise your specification, eg. 943025LSMB

TECHNICAL DRAWINGS

PRODUCT DIMENSIONS

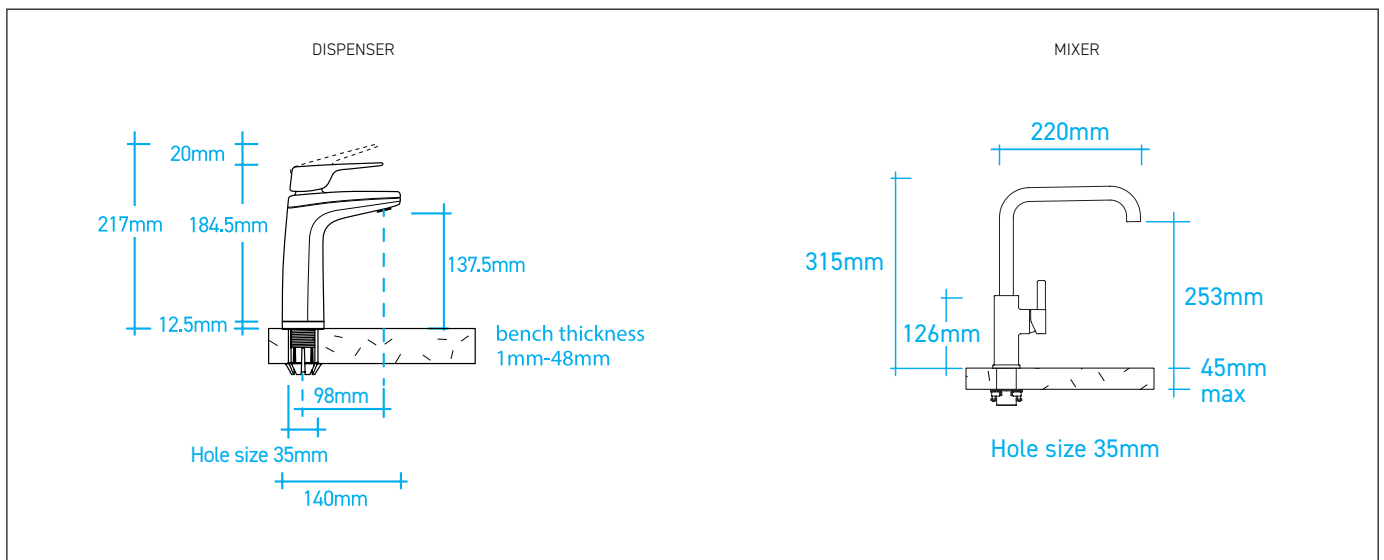

INSTALLATION REQUIREMENTS

PREFERRED INSTALLATION LAYOUT

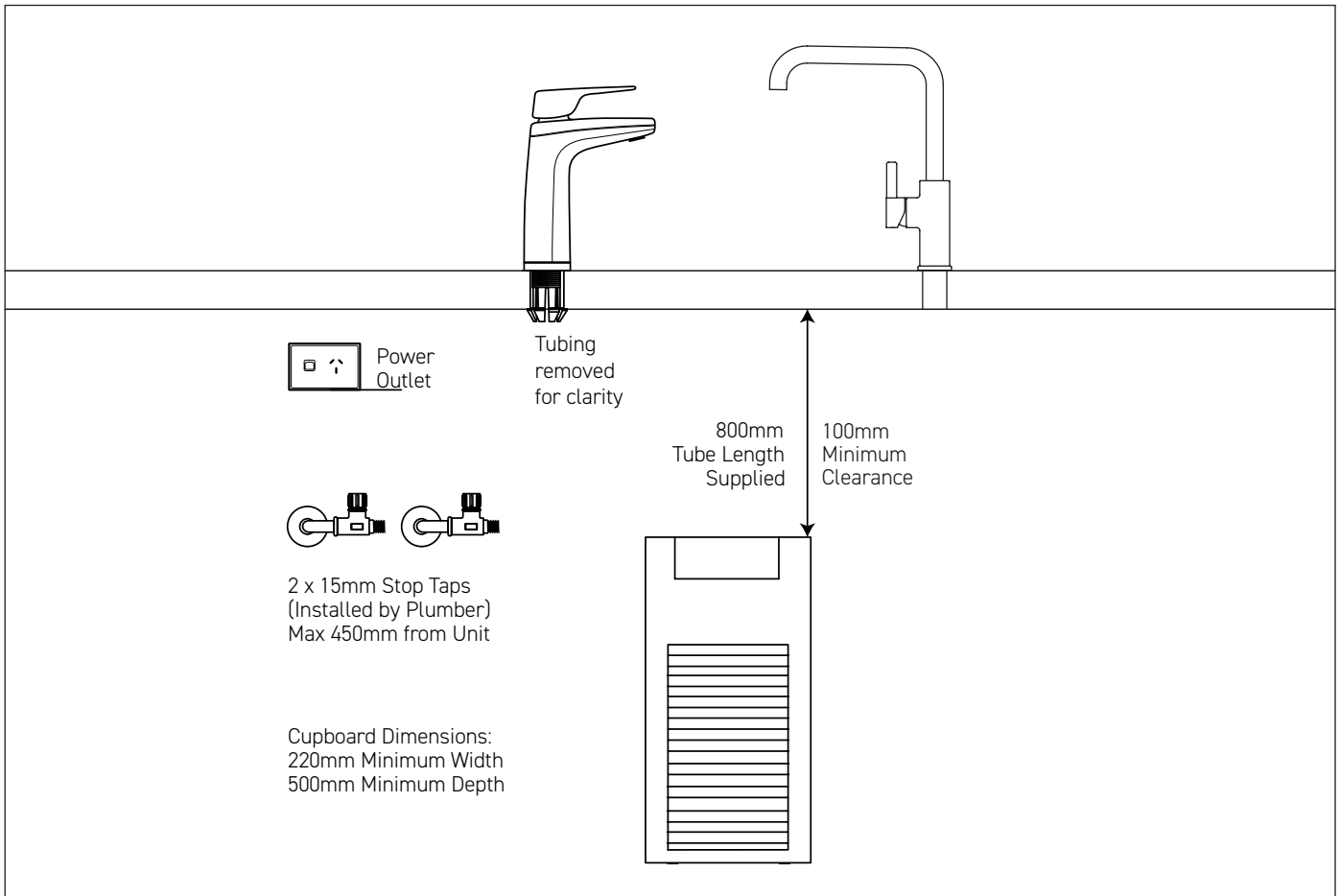

WATER SUPPLY

Two (2) 1/2" BSP (15mm) stop-taps with a male thread should be installed in an easily accessible position. Water supply must be microbiologically safe to drink, with a minimum dynamic water pressure of 250kPa and a maximum of 1000kPa.

POWER SUPPLY

A standard 10 amp power outlet is required, no further than 1000mm from the underbench unit. The system is supplied with a 1 metre flex cord and plug.

FILTRATION

Billi's range of premium filters utilise BWT's unique Fibron X technology. Billi's filter range provides superior taste, water quality, consistent filter life and peace of mind when it comes to hygiene.

Filter supplied: 994051 (5 micron). Replacement filters available: 994052 (0.2 micron), 994054 (HSD), 994055 (XPHSD), 994056 (Sediment only) and 994060 (0.2 micron sediment only).

CERTIFICATIONS

Every Billi drinking water appliance is manufactured under a certified quality control system. All Billi commercial range models have been tested and comply with all required standards including: WaterMark: WM-021525; Certified to AS/NZ3498 and AS/NZ 4020; ISO9001:2015, QEC 11627; Section J6.6 of the BCA; HACCP: PE-872-WAT-1-02; WELL Cornerstone Member; WELS 6 star rating registration T40038.

WARRANTY

The Billi Sahara Plus Range is covered by a comprehensive 2 year warranty on all parts and labour.

Billi®

Billi Australia Pty Ltd
42 Lucknow Crescent,
Thomastown, Victoria
3074 Australia

P 1800 812 321
F +61 3 9469 0499
W www.billi.com.au

visit us at



Designed and manufactured in  Australia to the highest quality standards